

# Installation Guide



Garden Flagpole - Standard 2 Piece External - Ground Sleeve

6m

# Garden Flagpole - Standard 2 Piece External - Ground Sleeve

## Parts Checklist

- A 2 x Aluminium Powder Coated Pole (3m)
- B 1 x Ground Sleeve & Cap (750mm x 64mm)
- C 1 x Joint (53mm x 448mm)
- D 1 x Mushroom Finial Base
- E 1 x Mushroom Finial Top
- F 1 x Aluminium Insert
- G 1 x Large Gold Finial (Optional Extra)
- H 1 x Fairlead & Saddle 54mm (Optional Extra)
- I 1 x Cleat
- J 2 x Cleat Screws
- K 1 x Halyard (Supplied at double the length of the flagpole)

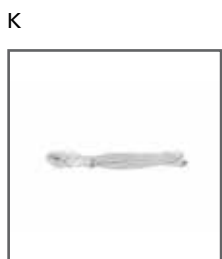
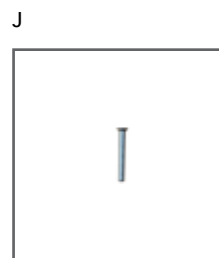
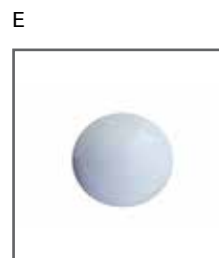
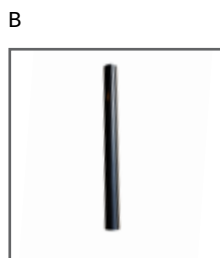
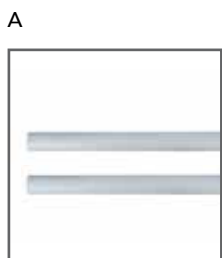

# Garden Flagpole - Standard 2 Piece External - Ground Sleeve

## Step 1

- » Dig foundation to required size see diagram (larger if ground is very sandy).
- » Order / mix concrete and place into hole (25 - 30 Newton - 50 slump - 20mm aggregate).
- » Ensure cap is fitted to ground sleeve to stop concrete from filling the sleeve.
- » Insert ground sleeve vertically into concrete, capped end first. Use spirit level to ensure ground sleeve is vertical. You may prefer to hold the ground sleeve in position with weighted cross batons.
- » Leave foundation to set for several days.

Ground Sleeve Installation - See Below (Flagpole Dimensions)

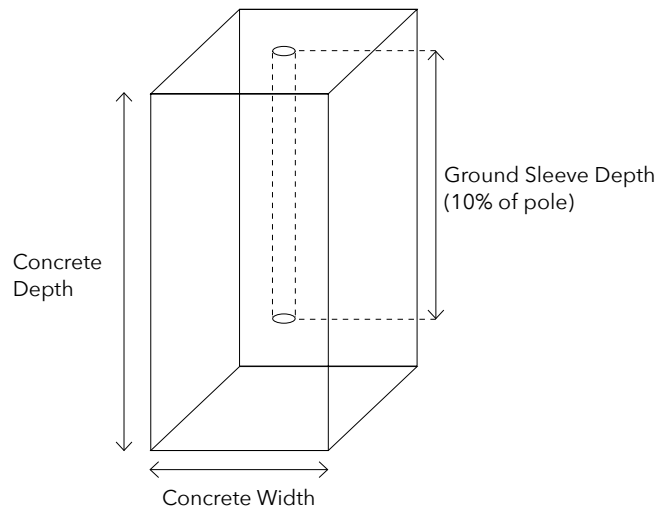

Flagpole Dimensions	
Appearance	Cylinder
Material	Aluminium
Flagpole Length (m)	6
Butt Diameter Ø (mm)	60
Top Diameter Ø (mm)	60
Colour	White
Sections (pieces)	2
Recommended Flag Size (mm)	1830 x 910
Base Fixing	Ground Sleeve
Foundation Required (w2 x d) (mm)	500 x 1000
Maximum Wind Speeds (mph Flagged)	30

**NB:** We recommend that the concrete used in the bases should be of a C30 quality as normally purchased from a ready mixed concrete supplier. If purchaser is to mix concrete up themselves then the ratio of the mix i.e. Cement/Sand/Fine Aggregate must 1:2:3 which results in a very strong mix. Any deviation from the above advise may result in warranty claims being invalid. If in any doubt please contact supplier for clarification.

# Garden Flagpole - Standard 2 Piece External - Ground Sleeve

## Step 2

Using a flat headed screw driver, attach the cleat to the pole using the 2 cleat screws provided.



## Step 3

Insert joint into bottom pole section and slide up to shoulder. Insert top section onto the joint and slide up to the shoulder.



## Step 4 - Mushroom Finial

Thread halyard through the mushroom finial base over the aluminium insert and back through the rear hole.



## Step 5

Line up the top of the mushroom finial base and click into place with the mushroom finial top.



## Step 6

Slide the complete mushroom finial into the top of the aluminium pole section.



## Step 4 - Gold Finial

Attach the gold finial to the fairlead & saddle by screwing the sections together as shown. Hand tighten only.



## Step 5

Slide the assembled finial section into the top of the pole.



# Garden Flagpole - Standard 2 Piece External - Ground Sleeve

## Step 6

Thread the halyard through the fairlead and saddle. Ensure there is an equal amount of halyard either side.



## Step 7

To erect the pole, slide the assembled 6m pole into the ground sleeve once the concrete has completely set.

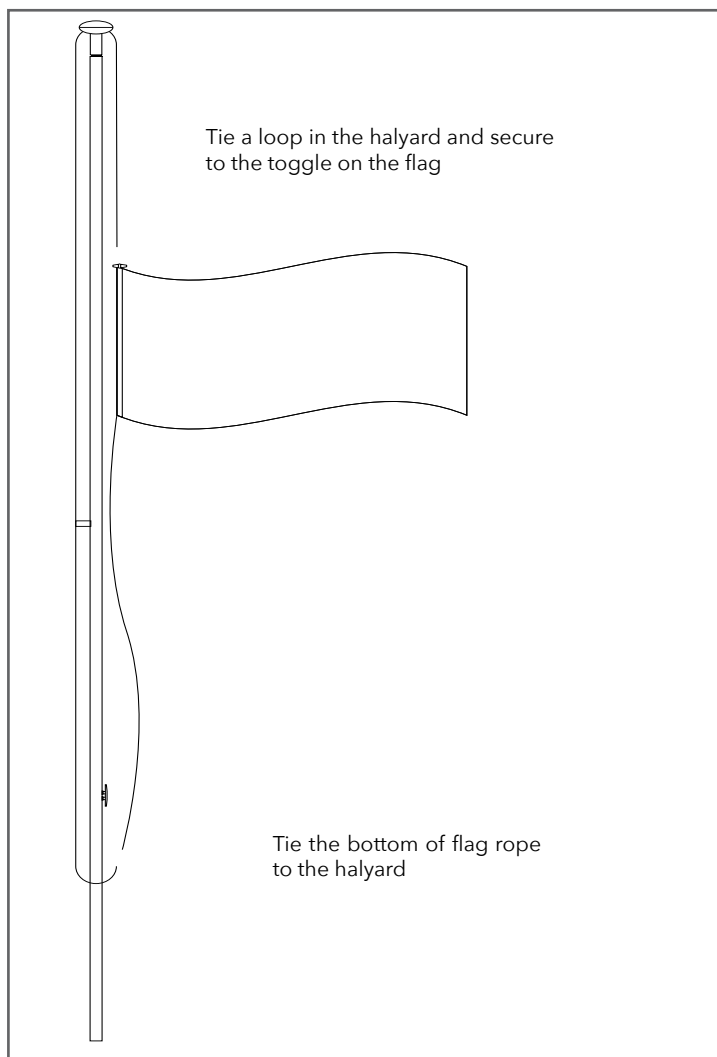

## Step 8

Keeping the halyard taut, hoist the flag until the toggle reaches the finial. Wrap excess halyard around the cleat. After attaching flag, wrap the halyard around cleat to tension.

